

Drive Isolation Transformers: 7.5–440 kVA, Three Phase

Special Voltages and kVA Sizes for Drive Applications

For SCR (Silicon Control Rectifier) variable speed motor drive applications, a transformer is needed to magnetically isolate the incoming line from the motor drive. The transformer must also provide a voltage change to match the required voltage of the SCR Drive. Standard designs are delta primary and wye secondary to match the common power sources required in most three phase rectifier circuits.

Hevi-Duty drive isolation transformers are specifically designed to handle the mechanical stresses, voltage demands and harmonics associated with SCR applications.

Features

- Available from 7.5 thru 440 kVA, 3 Phase, 60 Hz.
- Isolation minimizes load disturbances caused by the SCR drive.
- UL-3R enclosures when used with optional weather shield.
- Taps on all units for adjustments to incoming source voltage. Full capacity secondary neutral as required by the National Electric Code.
- Shielding attenuates line to ground noise.
- 10 year warranty

Related Products

- Surge Protective Devices
- Line Reactors
- K-13 Rated Transformers for Variable Frequency Drives

Accessories

- Weather Shields

Applications

- SCR Variable Speed Drives

Design Styles

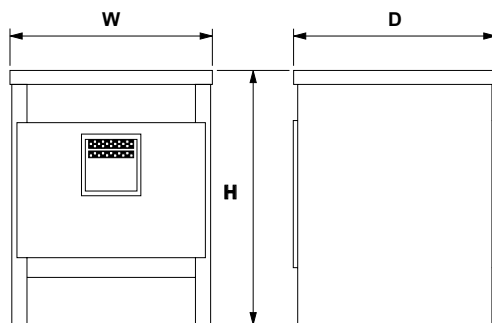

Style 1 - Ventilated

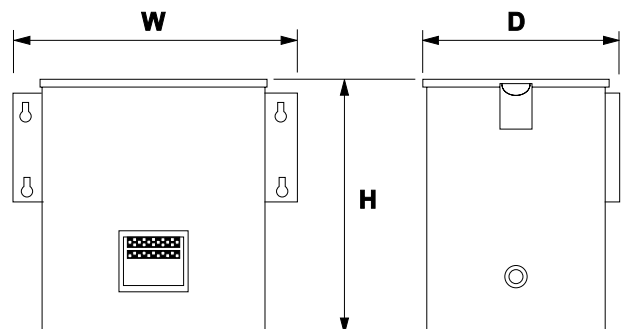

Style 4 - Encapsulated



Sizing Information (from Selection Table)

To properly size a drive isolation transformer, follow the drive manufacturer’s recommendations or, if you know the motor horsepower, select the proper kVA from the Selection Table on the next page. See the Transformer Sizing section of Chapter 6 (Distribution Transformers).

Note: Other voltage combinations available. Contact Technical Services.

Available upon special order:

- Totally enclosed, non-ventilated units (Non-UL Listed)
- Copper wound transformers

Selection Table: Three Phase



kVA	Drive Horse Power	Group I Catalog Number	Group II Catalog Number	Group III Catalog Number	NEMA 3R Weather Shield ⁽¹⁾	Dimensions			Ship Weight lbs (kg)	Design Style
		460 Δ Primary 460Y/266 Secondary 60 Hz	460 Δ Primary 230Y/133 Secondary 60 Hz	575 Δ Primary 230Y/133 Secondary 60 Hz		Height (inch)	Width (inch)	Depth (inch)		
7.5 ⁽²⁾	5	DT651F7.5S	DT661F7.5S	DT631F7.5S	N/A ⁽²⁾	17	20	10	236 (107)	4
11 ⁽³⁾	7.5	DT651H11S	DT661H11S	DT631H11S	WS-02	23	18	14	166 (72)	1
14 ⁽³⁾	10	DT651H14S	DT661H14S	DT631H14S	WS-02	23	18	14	180 (82)	1
20	15	DT651H20S	DT661H20S	DT631H20S	WS-02	23	18	14	210 (95)	1
27	20	DT651H27S	DT661H27S	DT631H27S	WS-14	28	23	16	277 (126)	1
34	25	DT651H34S	DT661H34S	DT631H34S	WS-14	28	23	16	309 (140)	1
40	30	DT651H40S	DT661H40S	DT631H40S	WS-14	28	23	16	329 (149)	1
51	40	DT651H51S	DT661H51S	DT631H51S	WS-14	28	23	16	372 (169)	1
63	50	DT651H63S	DT661H63S	DT631H63S	WS-30	34	28	22	479 (217)	1
75	60	DT651H75S	DT661H75S	DT631H75S	WS-30	34	28	22	510 (231)	1
93	75	DT651H93S	DT661H93S	DT631H93S	WS-30	34	28	22	637 (289)	1
118	100	DT651H118S	DT661H118S	DT631H118S	WS-10	44	33	21	910 (413)	1
145	125	DT651H145S	DT661H145S	DT631H145S	WS-10	44	33	21	920 (417)	1
175	150	DT651H175S	DT661H175S	DT631H175S	WS-11	46	36	24	1150 (522)	1
220	200	DT651H220S	DT661H220S	DT631H220S	WS-11	46	36	24	1280 (581)	1
275	250	DT651H275S	DT661H275S	DT631H275S	WS-11	46	36	24	1415 (642)	1
330	300	DT651H330S	DT661H330S	DT631H330S	WS-11	46	36	24	1525 (692)	1
440	400	DT651H440S	DT661H440S	DT631H440S	WS-12	65	45	35	2450 (1111)	1

1. Weather shields come in a set of two and must be ordered separately.

2. Encapsulated. No weather shield required. cULus E77014.

3. Units are CSA marked.

Electrical Connection Key

Electrical Connection Number

Group I	
7.5 kVA	1
11-440 kVA	4
Group II	
7.5 kVA	2
11-440 kVA	5
Group III	
7.5 kVA	3
11-440 kVA	6

Electrical Connections

460 Δ Primary, 460Y/266 Volt Secondary
Taps: 1,5% FCAN; 1,5% FCBN

1

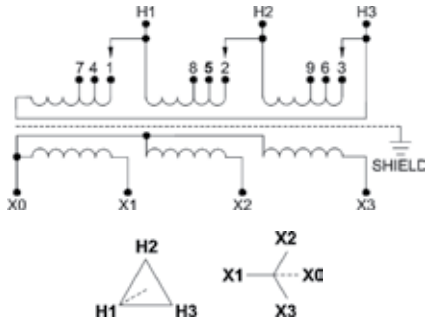

Primary Voltage	Connect	Line Leads
483	1-H1 & 2-H2 & 3-H3	H1, H2, H3
460	4-H1 & 5-H2 & 6-H3	H1, H2, H3
437	7-H1 & 8-H2 & 9-H3	H1, H2, H3
Secondary Voltage		Line Leads
460		X1, X2, X3
266		X0-X1, X2, X3

460 Δ Primary, 230Y/133 Volt Secondary
Taps: 1,5% FCAN; 1,5% FCBN

2

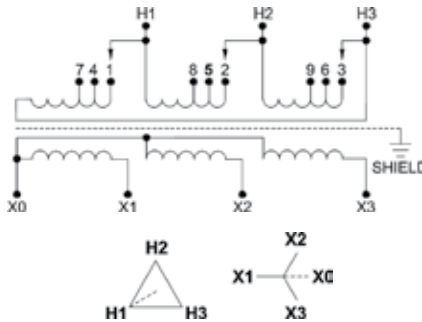

Primary Voltage	Connect Taps	Line Leads
483	1-H1 & 2-H2 & 3-H3	H1, H2, H3
460	4-H1 & 5-H2 & 6-H3	H1, H2, H3
437	7-H1 & 8-H2 & 9-H3	H1, H2, H3
Secondary Voltage		Line Leads
230		X1, X2, X3
133		X0-X1, X2, X3

575 Δ Primary, 230Y/133 Volt Secondary
Taps: 1,5% FCAN; 1,5% FCBN

3

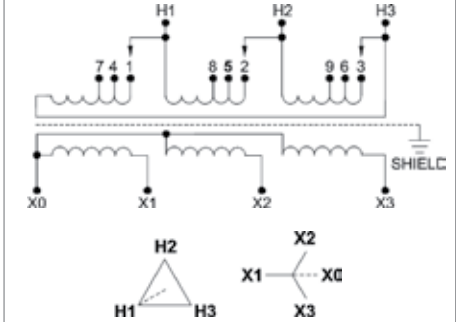

Primary Voltage	Connect Taps	Line Leads
604	1-H1 & 2-H2 & 3-H3	H1, H2, H3
575	4-H1 & 5-H2 & 6-H3	H1, H2, H3
546	7-H1 & 8-H2 & 9-H3	H1, H2, H3
Secondary Voltage		Line Leads
230		X1, X2, X3
133		X0-X1, X2, X3

460 Δ Primary, 460Y/266 Volt Secondary
Taps: 1,5% FCAN; 1,5% FCBN

4

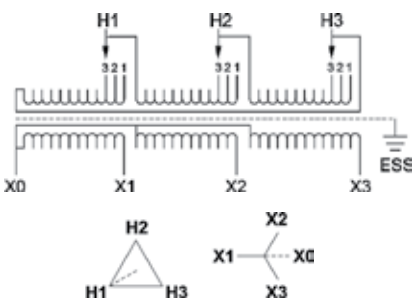

Primary Voltage	H1-H2-H3	Secondary Voltage	
@ Tap	Voltage	X1, X2, X3	X0-X1, X2, X3
1	483	460	266
2	460		
3	437		

460 Δ Primary, 230Y/133 Volt Secondary
Taps: 1,5% FCAN; 1,5% FCBN

5

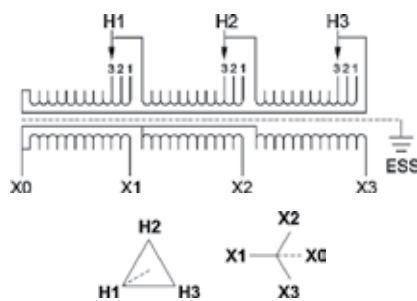

Primary Voltage	H1-H2-H3	Secondary Voltage	
@ Tap	Voltage	X1, X2, X3	X0-X1, X2, X3
1	483	230	133
2	460		
3	437		

575 Δ Primary, 230Y/133 Volt Secondary
Taps: 1,5% FCAN; 1,5% FCBN

6

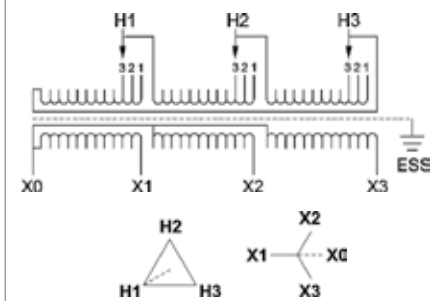

Primary Voltage	H1-H2-H3	Secondary Voltage	
@ Tap	Voltage	X1, X2, X3	X0-X1, X2, X3
1	604	230	133
2	575		
3	547		